

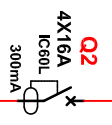

ICC IK3 MAX 20KA

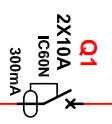

CABLE CR1-C1  
CABLE CR1-C1

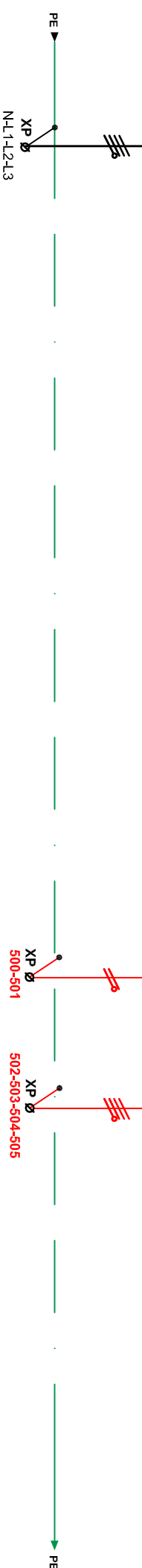

REPERE	-	AL 106	AL EXTRACTION		
DESIGNATION	DEPUIS TARIF JAUNE ENEDIS	ALIMENTATION INCENDIE	ALIMENTATION EXTRACTION LTR+1		
APPAREIL					
SECTION		3G1,5 CR1 C1	5G2,5 CR1 C1		
PUISS - KW	400A	0,5	3		

BDP		TGBT		N° FOLIO
N° AFFAIRE		TGBT		
N° DOCUMENT		TGBT		
A	MAJ			2
IND	MODIFICATION			

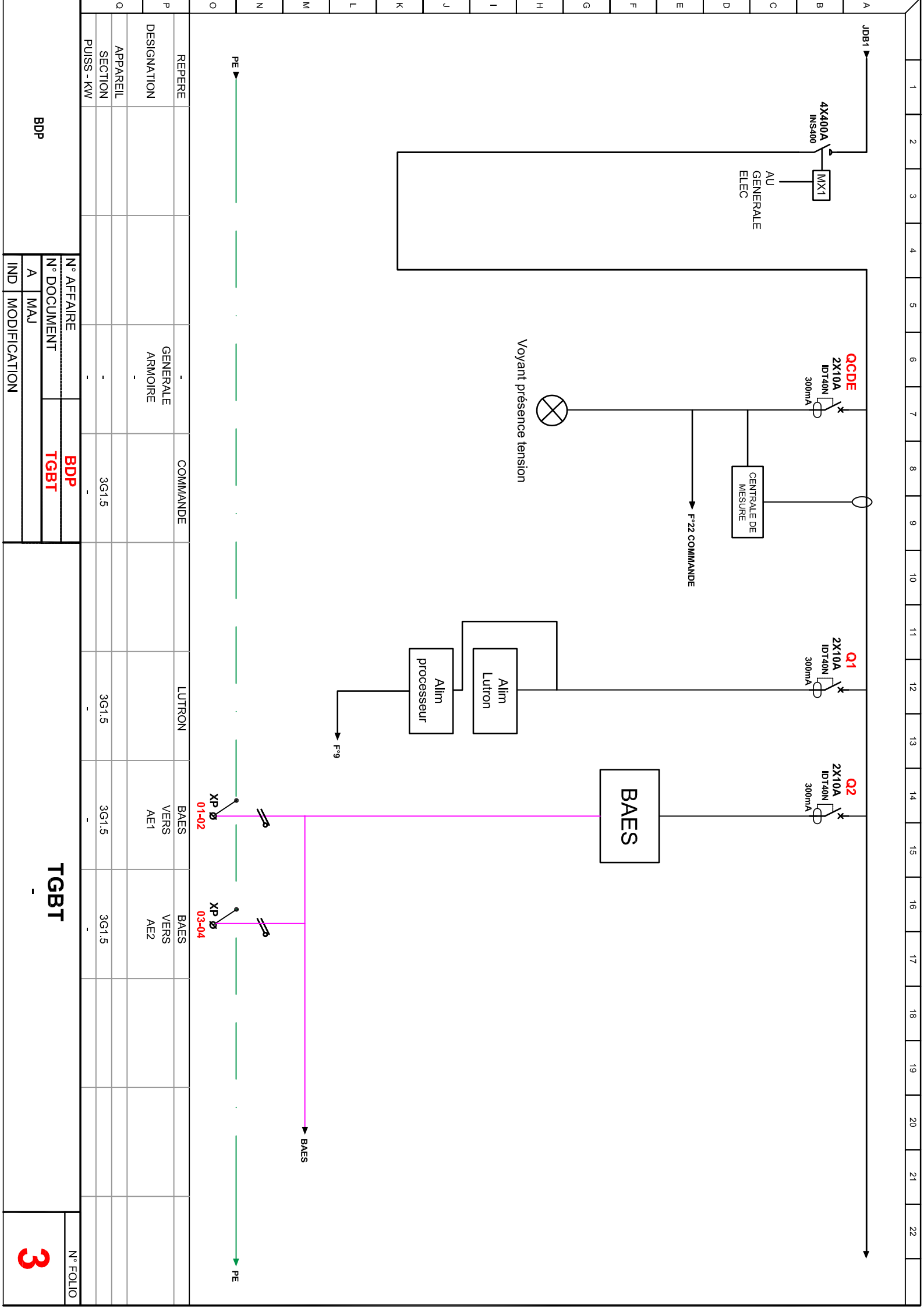

REPÈRE	-	COMMANDE	LUTRON	BAES VERS AE1	BAES VERS AE2
DESIGNATION	GENERALE ARMOIRE				
APPAREIL	-				
SECTION	-	3G1.5	3G1.5	3G1.5	3G1.5
PUISS - KW	-				

N° AFFAIRE		<b>BDP</b>
N° DOCUMENT		<b>TGBT</b>
A	MAJ	
IND	MODIFICATION	

N° AFFAIRE		<b>BDP</b>	N° AFFAIRE		
N° DOCUMENT		<b>TGBT</b>	N° DOCUMENT		
A	MAJ		N° AFFAIRE		
IND	MODIFICATION		N° DOCUMENT		
			<b>TGBT</b>		
					N° FOLIO
					<b>3</b>

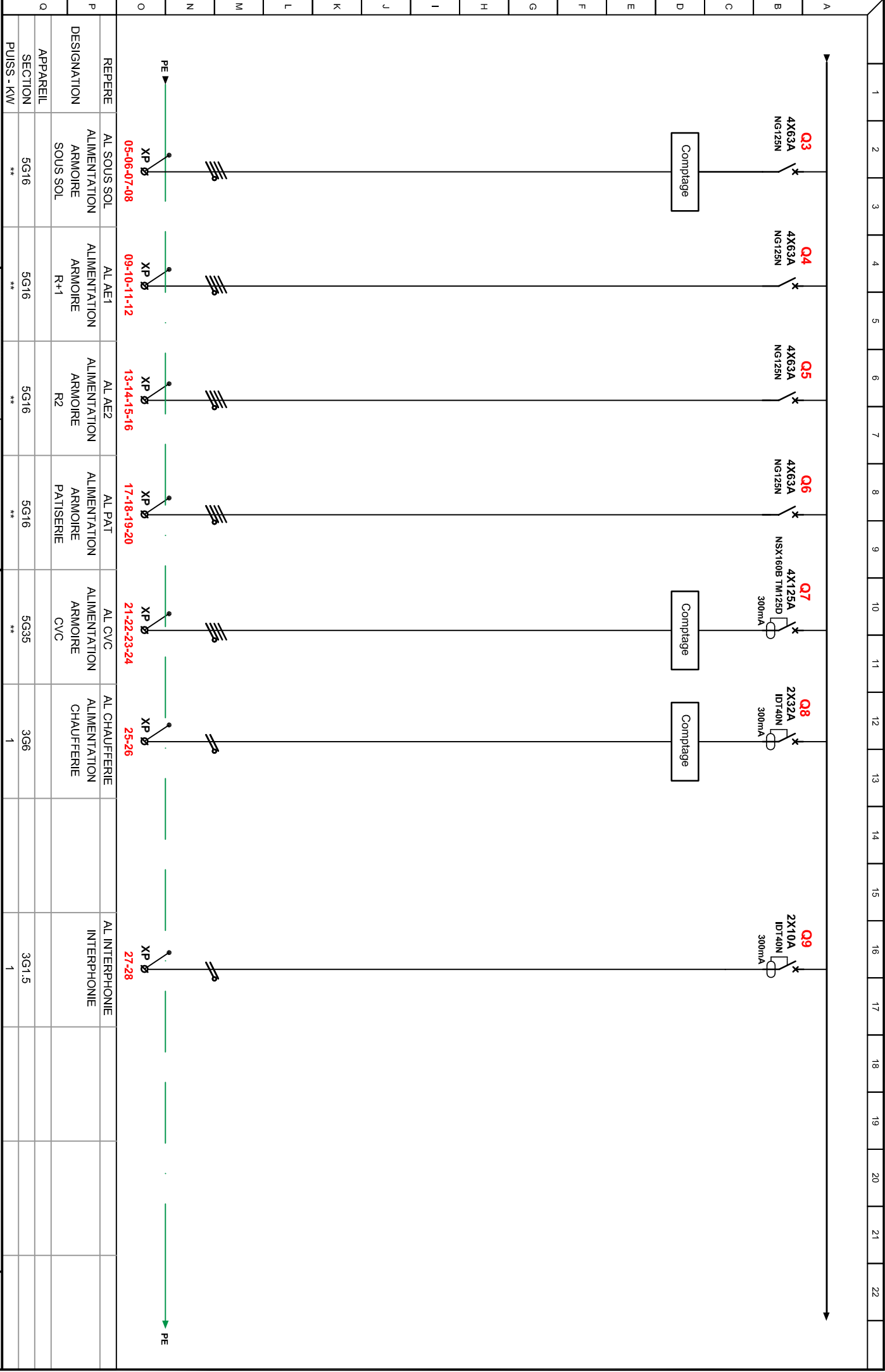

P	REPERE	AL SOUS SOL	AL AE1	AL AE2	AL PAT	AL CVC	AL CHAUFFERIE	AL INTERPHONIE
	DESIGNATION	ALIMENTATION ARMOIRE SOUS SOL	ALIMENTATION ARMOIRE R+1	ALIMENTATION ARMOIRE R2	ALIMENTATION ARMOIRE PATISERIE	ALIMENTATION ARMOIRE CVC	ALIMENTATION CHAUFFERIE	INTERPHONIE
Q	APPAREIL	5G16	5G16	5G16	5G16	5G35	3G6	3G1.5
	SECTION	5G16	5G16	5G16	5G16	5G35	3G6	3G1.5
PUISS. - KW		**	**	**	**	**	1	1
N° AFFAIRE		<b>BDP</b>						
N° DOCUMENT		<b>TGBT</b>						
A MAJ								
IND MODIFICATION								
<b>BDP</b>								<b>TGBT</b>
								N° FOLIO
								<b>4</b>



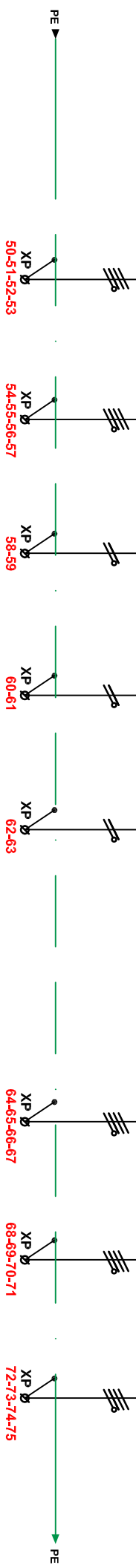
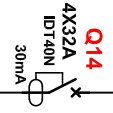

REPERE	GENERALE	PC-TRI1	PC-TRI2	PC-OSMO	PC-FRIGO	PC-02	GENERALE	AL-MP02	AL-MP03	AL-ASC
DESIGNATION	BAR	PC TRI	PC TRI	OSMOSEUR	FRIGO	PC	MONTRE CHARGE	MONTRE PLAT 02	MONTRE PLAT 03	ASC
APPAREIL	-									
SECTION		5G2.5	5G2.5	3G2.5	3G2.5	3G2.5				
PUISS - KW	9						9			

**BDP**

N° AFFAIRE	<b>BDP</b>
N° DOCUMENT	<b>TGBT</b>
IND	MODIFICATION

**TGBT**

N° FOLIO

**6**

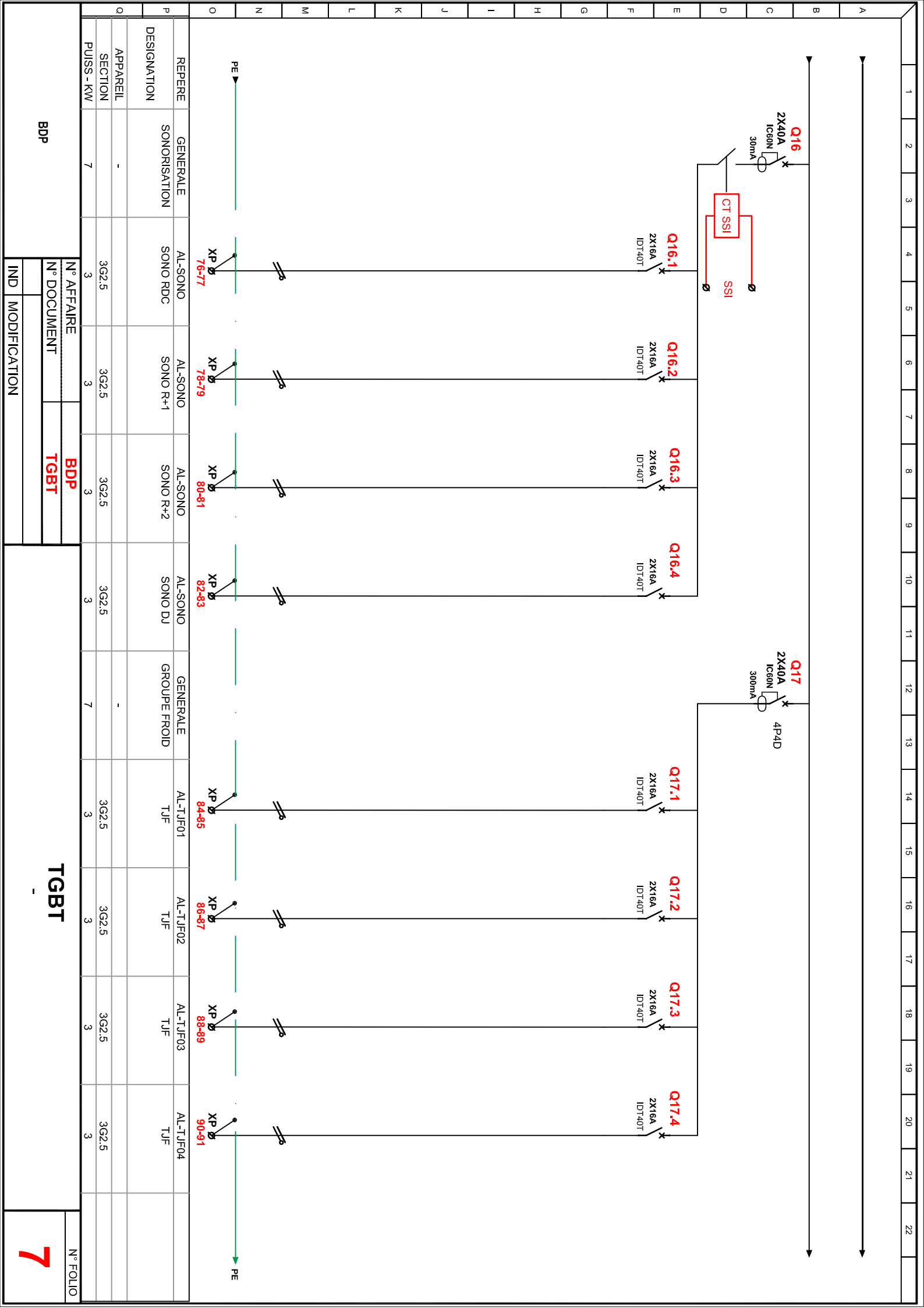

REPERE	GENERALE	AL-SONO	AL-SONO	AL-SONO	AL-SONO	GENERALE	AL-TJF01	AL-TJF02	AL-TJF03	AL-TJF04	
DESIGNATION	SONORISATION	SONO RDC	SONO R+1	SONO R+2	SONO DJ	GROUPE FROID	TJF	TJF	TJF	TJF	
APPAREIL	-	3G2.5	3G2.5	3G2.5	3G2.5	-	3G2.5	3G2.5	3G2.5	3G2.5	
SECTION	-	3G2.5	3G2.5	3G2.5	3G2.5	-	3G2.5	3G2.5	3G2.5	3G2.5	
PUISS. - KW	7	3	3	3	3	7	3	3	3	3	
N° AFFAIRE		BDP		BDP		TGBT		TGBT		TGBT	
N° DOCUMENT		TGBT		TGBT		TGBT		TGBT		TGBT	
IND		MODIFICATION		MODIFICATION		MODIFICATION		MODIFICATION		MODIFICATION	
BDP										TGBT	
IND										MODIFICATION	
N° FOLIO										7	

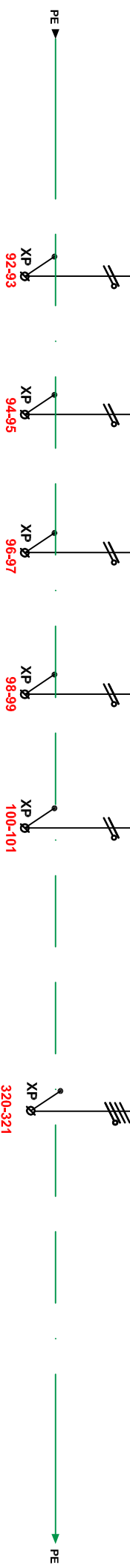
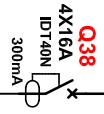
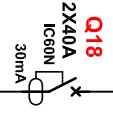

REPERE	GENERALE	PC EXTERIEUR	PC EXTERIEUR	LAMBREQUIN	NEON	ENSEIGNE	AL ASC
DESIGNATION	EXTERIEUR	PC EXTERIEUR	GUILPLANDE	LAMB	NEON	ENSEIGNE	ALIMENTATION ASC
APPAREIL	-						
SECTION	3G2.5	3G2.5	3G2.5	3G1.5	3G1.5	5G2.5	**
PUISS - KW	7	1	1	1	1	1	

**BDP**

N° AFFAIRE	<b>BDP</b>
N° DOCUMENT	<b>TGBT</b>
IND	MODIFICATION

TGBT

-

N° FOLIO

8



Comptage

**Q19**  
2X10A  
IDT40N  
300mA

**Q20**  
2X10A  
IDT40N  
300mA

MODULE VARIATION DE PHASE

MODULE VARIATION DE PHASE

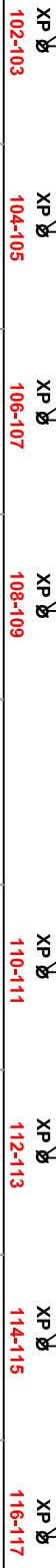

REPERE	VA01	VA02	VA03	VA04	VA05	VA06	VA07	VA08
DESIGNATION	ECLAIRAGE L02	ECLAIRAGE L06	ECLAIRAGE BAR	ECLAIRAGE L01	ECLAIRAGE ESCALIER	ECLAIRAGE ESCALIER	ECLAIRAGE EXTERIEUR	ECLAIRAGE TABLE
APPREIL								
SECTION	3G1.5	3G1.5	3G1.5	3G1.5	3G1.5	3G1.5	3G1.5	3G1.5
PUISS - KW	1	1	1	1	1	1	1	1

**BDP**

N° AFFAIRE	<b>BDP</b>
N° DOCUMENT	<b>AE1</b>
A MAJ	
IND MODIFICATION	

**TGBT**

-

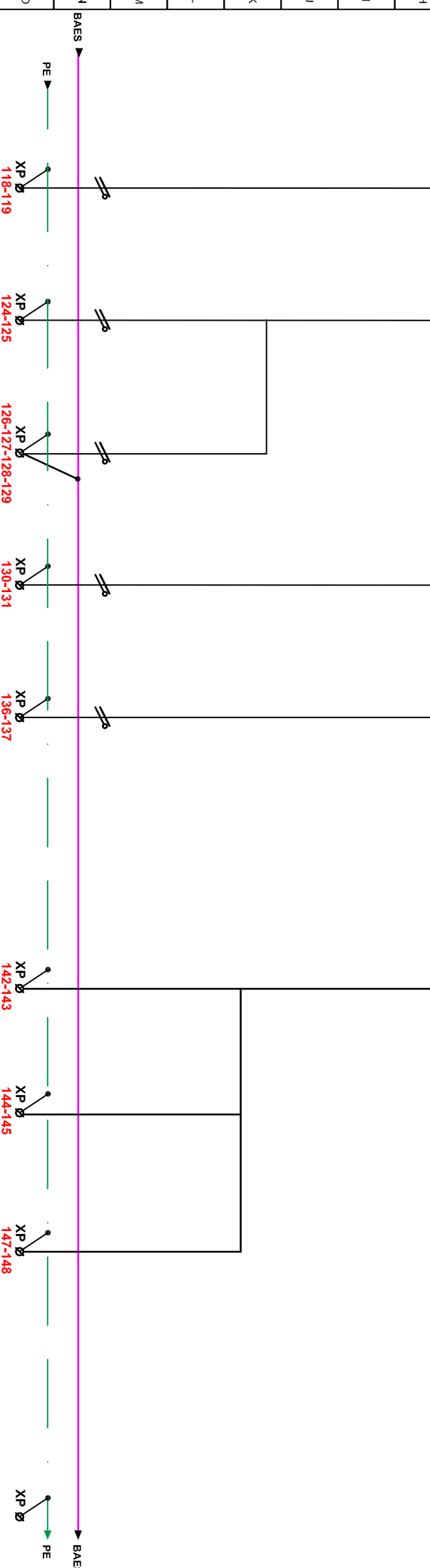
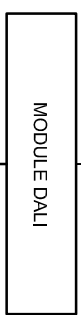
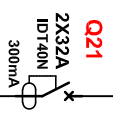

REPERE	DALI	DALI	BAES	DALI	DALI 11	DALI	DALI	DALI	DALI
DESIGNATION	DALI 01-02-03-04	DALI 05-06-07	BAES	DALI 07-08-09-10	PORTE MENUE				
APPAREIL									
SECTION	3G1.5	3G1.5	5G1.5	3G1.5	3G1.5				
PUISS - KW	1	1	1	1	1				

N° AFFAIRE		<b>BDP</b>
N° DOCUMENT		<b>AE1</b>
A	MAJ	
IND MODIFICATION		

<b>TGBT</b>		-
		<b>10</b>



REPERE	L01	L02	L03	L04	L05	L06	TGBT	ES-TGBT
DESIGNATION	LAMPES CHAUFFANTES	LAMPES CHAUFFANTES	LAMPES CHAUFFANTES	LAMPES CHAUFFANTES	LAMPES CHAUFFANTES	LAMPES CHAUFFANTES	ECL TGBT	BAES
APPAREIL SECTION	3G1.5	3G1.5	3G1.5	3G1.5	3G1.5	3G1.5	3G1.5	5G1.5
PUISS - KW	1	1	1	1	1	1	1	1

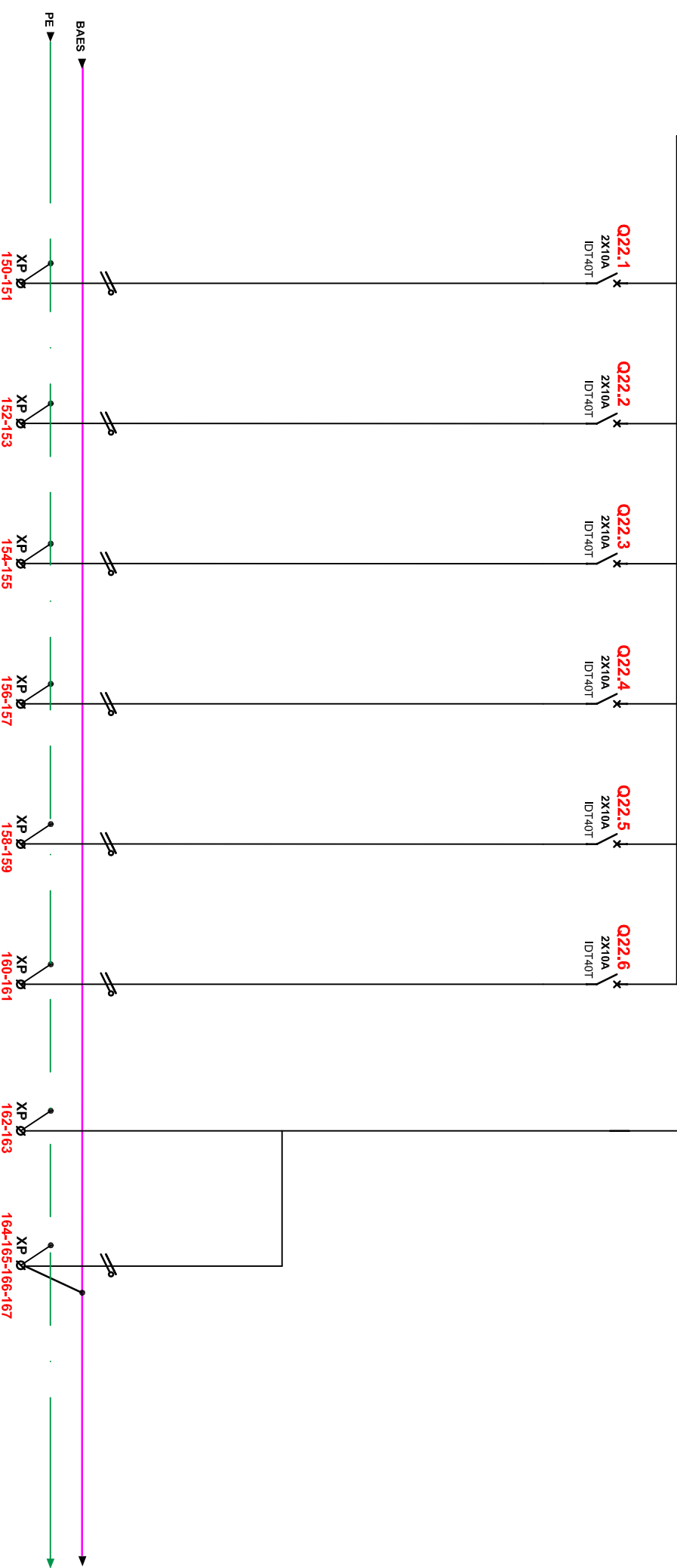
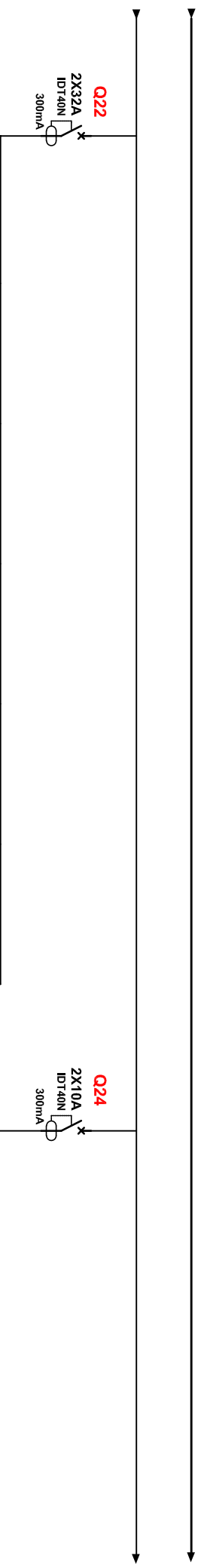

N° AFFAIRE		<b>BDP</b>
N° DOCUMENT		<b>AE1</b>
IND	MODIFICATION	

<b>TGBT</b>	
-	
N° FOLIO	
<b>11</b>	

JD81 ← A 1 2 3 4 5 6 7 8 9 10 11 12 13 14 15 16 17 18 19 20 21 22 → JD81

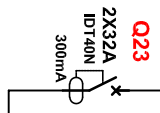

REPERE	EL01	ES-01	EL03	ES-03	EL04-EL07	ES-04	EL-HOTTE
DESIGNATION	ECLAIRAGE CUISINE	BAES	ECLAIRAGE LT SS	BAES	ECLAIRAGE LT SS	BAES	ECLAIRAGE HOTTE
APPAREIL SECTION	3G1.5	5G1.5	3G1.5	5G1.5	3G1.5	5G1.5	3G1.5
PUISS - KW	1	1	1	1	1	1	1

BDP

N° AFFAIRE	BDP
N° DOCUMENT	AE1
IND	MODIFICATION

TGBT

N° FOLIO 12



1 2 3 4 5 6 7 8 9 10 11 12 13 14 15 16 17 18 19 20 21 22



200-201-202-203 204-205-206-207 208-209 210-211 212-213 214-215

REPERE	GENERALE	PC-TRI03	PC-TRI4	PC-04	PC-10	PC-CC8	PC-06
DESIGNATION	PC CUISINE	PC TRI	PC TRI	PC	LT SOUS SOL	CELULE MIXTE	PC PLAN DE TRAVAIL CREDENCE
APPAREIL	-						
SECTION		5G2.5	5G2.5	3G2.5	3G2.5	3G2.5	3G2.5
PUISS - KW	7	3	3	1	1	1	1

**BDP**

N° AFFAIRE	<b>BDP</b>
N° DOCUMENT	<b>AE1</b>
IND	MODIFICATION

**TGBT**

N° FOLIO

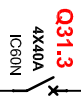
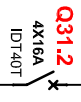
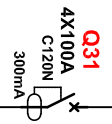

216-217 218-219-220-221 222-223-224-225 226-227-228-229 230-231-232-233

REPERE	GENERALE	AL-C2B	AL-C2A	AL-C3G8	AL-C5.1	AL-C5.2
DESIGNATION	CUISSON	ALIMENTATION HOTTE	FOUR	PLAQUE INDU	VARIO PLAQUE	VARIO PLAQUE
APPAREIL	-					
SECTION	3G2.5	5G2.5	5G6	5G2.5	5G2.5	5G2.5
PUISS - KW	43	0.2	9.3	20	7	7

**BDP**

N° AFFAIRE	<b>BDP</b>
N° DOCUMENT	<b>AE1</b>
IND	MODIFICATION

**TGBT**

N° FOLIO  
**15**

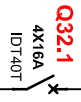
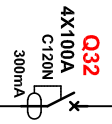

REPERE	GENERALE	AL-G5	AL-G1C	AL-G11A	AL-G10A
DESIGNATION	GARNITURE	VARIO PLAQUE	FRITEUSE	FOUR	FOUR
APPAREIL	-	5G2.5	5G6	5G2.5	5G6
SECTION		7	22	9.3	16
PUISS - KW	54				

234-235-236-237    238-239-240-241    242-243-244-245    246-247-248-249

**BDP**

N° AFFAIRE	<b>BDP</b>
N° DOCUMENT	<b>AE1</b>
IND	MODIFICATION

**TGBT**

**16**

N° FOLIO



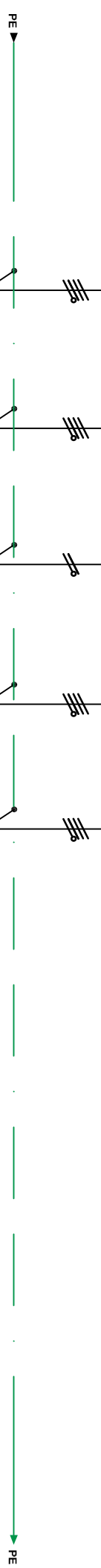
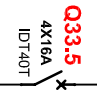
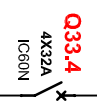
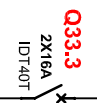
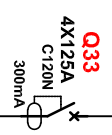

250-251-252-253 254-255-256-257 258-259 260-261-262-263 264-265-266-267

REPERE	GENERALE	AL-P1	AL-P2	AL-P3B	AL-P3A	AL-PB2
DESIGNATION	PATISERIE	SAUTEUSE	SAUTEUSE	ALIMENTATION HOTTE	FOUR	LV
APPAREIL	-					
SECTION	5G6	5G6	5G6	3G2.5	5G6	5G2.5
PUISS - KW	43	20	18	0.2	18	11.2

BDP

N° AFFAIRE	BDP
N° DOCUMENT	AE1
IND	MODIFICATION

TGBT

N° FOLIO

17



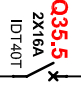
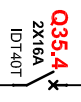
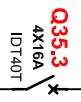
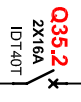
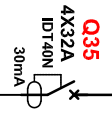

REPERE	GENERALE	PC-LG4A	AL-LG01	PC-LG6	PC-07
DESIGNATION	PC	PC ARMOIRE	ROBOT	MEUBLE FROID	PC LABO FROID
APPAREIL	-				
SECTION	3G2.5	3G2.5	5G2.5	3G2.5	3G2.5
PUISS - KW	5	1	7	1	1

BDP	N° AFFAIRE	BDP
	N° DOCUMENT	AE1
IND	MODIFICATION	
TGBT		
	N° FOLIO	19





DEFINIS CODE

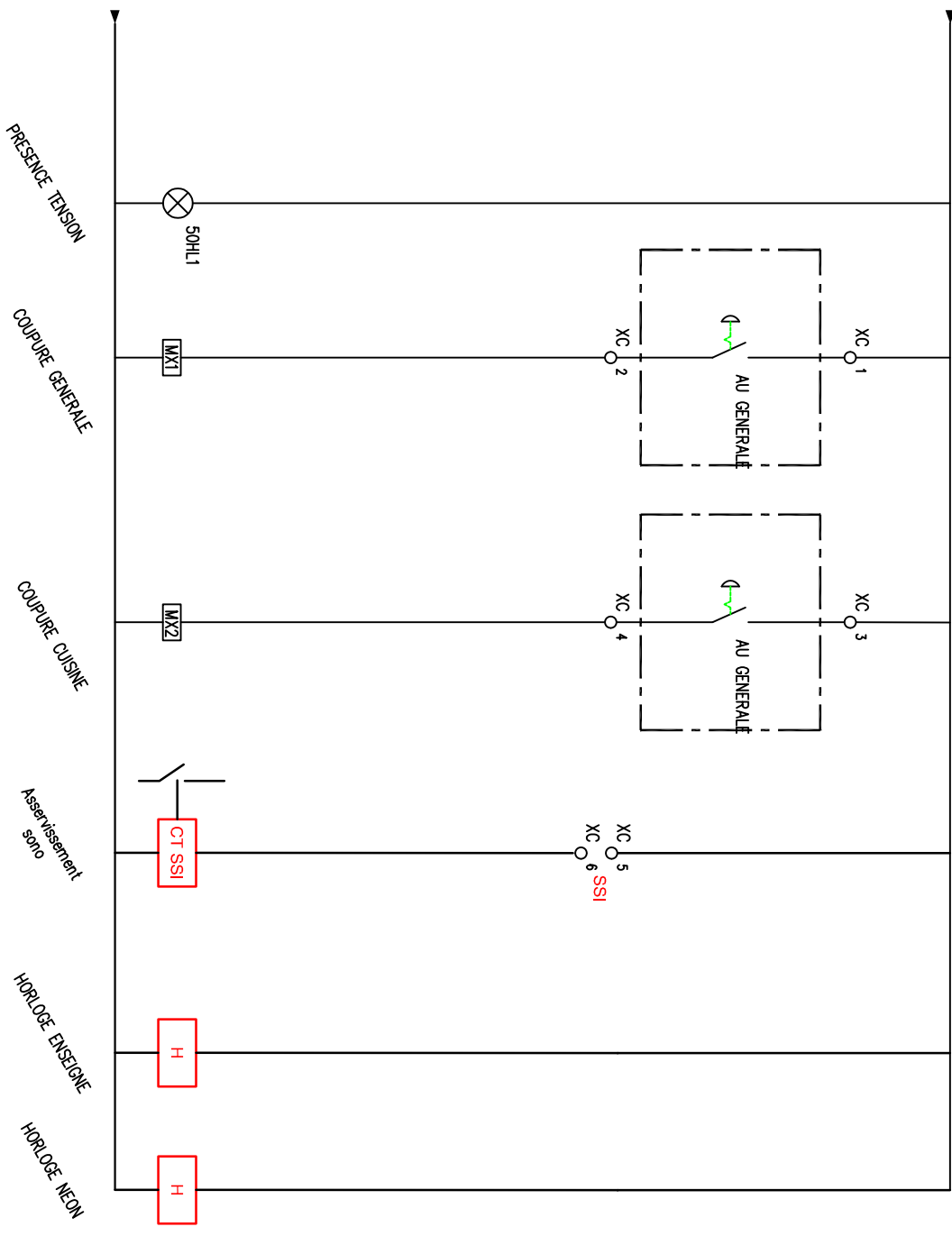

N° AFFAIRE		<b>BDP</b>	
N° DOCUMENT		<b>AE1</b>	
IND	MODIFICATION		

**TGBT**